

FEATURES

- High performance accelerometer**
- $\pm 70\text{ g}$, $\pm 250\text{ g}$, and $\pm 500\text{ g}$ wideband ranges available**
- 22 kHz resonant frequency structure**
- High linearity: 0.2% of full scale**
- Low noise: 4 mg/ $\sqrt{\text{Hz}}$**
- Sensitive axis in the plane of the chip**
- Frequency response down to dc**
- Full differential signal processing**
- High resistance to EMI/RFI**
- Complete electromechanical self-test**
- Output ratiometric to supply**
- Velocity preservation during acceleration input overload**
- Low power consumption: 2.5 mA typical**
- 8-terminal, hermetic ceramic, LCC package**

APPLICATIONS

- Vibration monitoring**
- Shock detection**
- Sports diagnostic equipment**
- Medical instrumentation**
- Industrial monitoring**

GENERAL DESCRIPTION

The ADXL001 is a major advance over previous generations of accelerometers providing high performance and wide bandwidth. This part is ideal for industrial, medical, and military applications where wide bandwidth, small size, low power, and robust performance are essential.

Using the Analog Devices, Inc. proprietary fifth-generation *iMEMS*[®] process enables the ADXL001 to provide the desired dynamic range that extends from $\pm 70\text{ g}$ to $\pm 500\text{ g}$ in combination with 22 kHz of bandwidth. The accelerometer output channel passes through a wide bandwidth differential-to-single-ended converter, which allows access to the full mechanical performance of the sensor.

The part can operate on voltage supplies from 3.3 V to 5 V.

The ADXL001 also has a self-test (ST) pin that can be asserted to verify the full electromechanical signal chain for the accelerometer channel.

The ADXL001 is available in the industry-standard 8-terminal LCC and is rated to work over the extended industrial temperature range (-40°C to $+125^{\circ}\text{C}$).

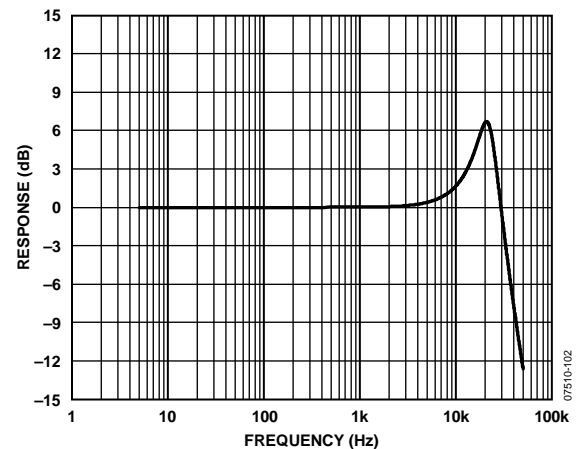

Figure 1. Sensor Frequency Response

FUNCTIONAL BLOCK DIAGRAM

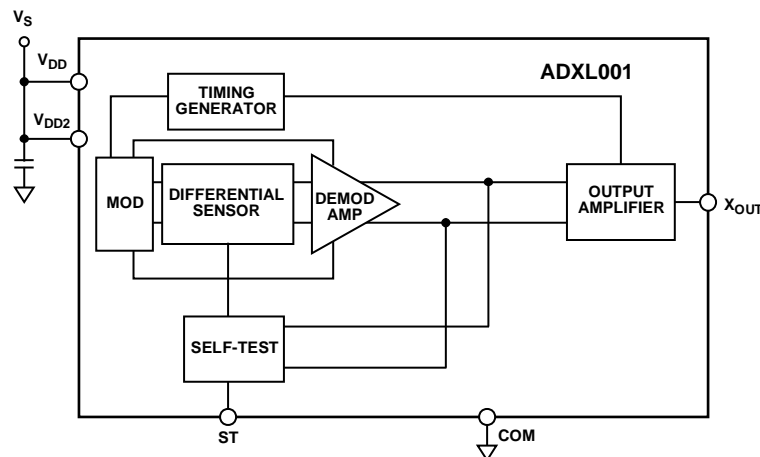

Figure 2.

Rev. A

Information furnished by Analog Devices is believed to be accurate and reliable. However, no responsibility is assumed by Analog Devices for its use, nor for any infringements of patents or other rights of third parties that may result from its use. Specifications subject to change without notice. No license is granted by implication or otherwise under any patent or patent rights of Analog Devices. Trademarks and registered trademarks are the property of their respective owners.

TABLE OF CONTENTS

Features	1	Design Principles.....	11
Applications.....	1	Mechanical Sensor	11
General Description	1	Applications Information	12
Functional Block Diagram	1	Application Circuit.....	12
Revision History	2	Self-Test	12
Specifications.....	3	Acceleration Sensitive Axis	12
Specifications for 3.3 V Operation	3	Operating Voltages Other Than 5 V.....	12
Specifications for 5 V Operation	4	Layout, Grounding, and Bypassing Considerations	13
Recommended Soldering Profile	5	Clock Frequency Supply Response	13
Absolute Maximum Ratings.....	6	Power Supply Decoupling.....	13
ESD Caution.....	6	Electromagnetic Interference	13
Pin Configuration and Function Descriptions.....	7	Outline Dimensions	14
Typical Performance Characteristics	8	Ordering Guide	14
Theory of Operation	11		

REVISION HISTORY

2/10—Rev. 0 to Rev. A

Added -250 and -500 models	Universal
Changes to Table 1.....	3
Changes to Table 2.....	4
Added Figure 9 through Figure 18.....	8
Changes to Ordering Guide	14

1/09—Revision 0: Initial Version

SPECIFICATIONS

SPECIFICATIONS FOR 3.3 V OPERATION

$T_A = -40^{\circ}\text{C}$ to $+125^{\circ}\text{C}$, $V_S = 3.3\text{ V} \pm 5\%$ dc, acceleration = 0 g, unless otherwise noted.

Table 1.

Parameter	Conditions	ADXL001-70			ADXL001-250			ADXL001-500			Unit
		Min	Typ	Max	Min	Typ	Max	Min	Typ	Max	
SENSOR											
Nonlinearity	Includes package alignment		0.2	2		0.2	2		0.2	2	%
Cross-Axis Sensitivity			2			2			2		%
Resonant Frequency				22			22			22	kHz
Quality Factor				2.5			2.5			2.5	
SENSITIVITY											
Full-Scale Range	$I_{OUT} \leq \pm 100\ \mu\text{A}$	-70		+70	-250		+250	-500		+500	g
Sensitivity	100 Hz		16.0			4.4			2.2		mV/g
OFFSET											
Zero-g Output	Ratiometric	1.35	1.65	1.95	1.35	1.65	1.95	1.35	1.65	1.95	V
NOISE											
Noise	10 Hz to 400 Hz		85			95			105		mg rms
Noise Density	10 Hz to 400 Hz		3.3			3.65			4.25		mg/ $\sqrt{\text{Hz}}$
FREQUENCY RESPONSE											
-3 dB Frequency			32			32			32		kHz
-3 dB Frequency Drift Over Temperature			2			2			2		%
SELF-TEST											
Output Voltage Change			400			125			62		mV
Logic Input High		2.1			2.1			2.1			V
Logic Input Low				0.66			0.66			0.66	V
Input Resistance	To ground	30	50		30	50		30	50		k Ω
OUTPUT AMPLIFIER											
Output Swing	$I_{OUT} = \pm 100\ \mu\text{A}$	0.2		$V_S - 0.2$	0.2		$V_S - 0.2$	0.2		$V_S - 0.2$	V
Capacitive Load		1000			1000			1000			pF
PSRR (CFSR)											
	DC to 1 MHz		0.9			0.9			0.9		V/V
POWER SUPPLY (V_S)											
Functional Range		3.135		6	3.135		6	3.135		6	V
I_{SUPPLY}			2.5	5		2.5	5		2.5	5	mA
Turn-On Time			10			10			10		ms

ADXL001

SPECIFICATIONS FOR 5 V OPERATION

$T_A = -40^{\circ}\text{C}$ to $+125^{\circ}\text{C}$, $V_S = 5\text{ V} \pm 5\%$ dc, acceleration = 0 g, unless otherwise noted.

Table 2.

Parameter	Conditions	ADXL001-70			ADXL001-250			ADXL001-500			Unit
		Min	Typ	Max	Min	Typ	Max	Min	Typ	Max	
SENSOR											
Nonlinearity	Includes package alignment		0.2	2		0.2	2		0.2	2	%
Cross-Axis Sensitivity			2			2			2		%
Resonant Frequency				22			22			22	kHz
Quality Factor				2.5			2.5			2.5	
SENSITIVITY											
Full-Scale Range	$I_{OUT} \leq \pm 100\ \mu\text{A}$	-70		+70	-250		+250	-500		+500	g
Sensitivity	100 Hz		24.2			6.7			3.3		mV/g
OFFSET											
Zero-g Output	Ratiometric	2.00	2.5	3.00	2.00	2.5	3.00	2.00	2.5	3.00	V
NOISE											
Noise	10 Hz to 400 Hz		55			60			70		mg rms
Noise Density	10 Hz to 400 Hz		2.15			2.35			2.76		mg/ $\sqrt{\text{Hz}}$
FREQUENCY RESPONSE											
-3 dB Frequency			32			32			32		kHz
-3 dB Frequency Drift Over Temperature			2			2			2		%
SELF-TEST											
Output Voltage Change			1435			445			217		mV
Logic Input High		3.3			3.3			3.3			V
Logic Input Low				0.66			0.66			0.66	V
Input Resistance	To ground	30	50		30	50		30	50		k Ω
OUTPUT AMPLIFIER											
Output Swing	$I_{OUT} = \pm 100\ \mu\text{A}$	0.2		$V_S - 0.2$	0.2		$V_S - 0.2$	0.2		$V_S - 0.2$	V
Capacitive Load		1000			1000			1000			pF
PSRR (CFSR)											
	DC to 1 MHz		0.9			0.9			0.9		V/V
POWER SUPPLY (V_S)											
Functional Range		3.135		6	3.135		6	3.135		6	V
I_{SUPPLY}			4.5	9		4.5	9		4.5	9	mA
Turn-On Time			10			10			10		ms

RECOMMENDED SOLDERING PROFILE

Table 3. Soldering Profile Parameters

Profile Feature	Sn63/Pb37	Pb-Free
Average Ramp Rate (T_L to T_P)	3°C/sec maximum	3°C/sec maximum
Preheat		
Minimum Temperature (T_{SMIN})	100°C	150°C
Maximum Temperature (T_{SMAX})	150°C	200°C
Time (T_{SMIN} to T_{SMAX}), t_s	60 sec to 120 sec	60 sec to 150 sec
T_{SMAX} to T_L		
Ramp-Up Rate	3°C/sec	3°C/sec
Time Maintained Above Liquidous (t_L)		
Liquidous Temperature (T_L)	183°C	217°C
Liquidous Time (t_L)	60 sec to 150 sec	60 sec to 150 sec
Peak Temperature (T_P)	240°C + 0°C/-5°C	260°C + 0°C/-5°C
Time Within 5°C of Actual Peak Temperature (t_p)	10 sec to 30 sec	20 sec to 40 sec
Ramp-Down Rate	6°C/sec maximum	6°C/sec maximum
Time 25°C to Peak Temperature (t_{PEAK})	6 minute maximum	8 minute maximum

Soldering Profile Diagram

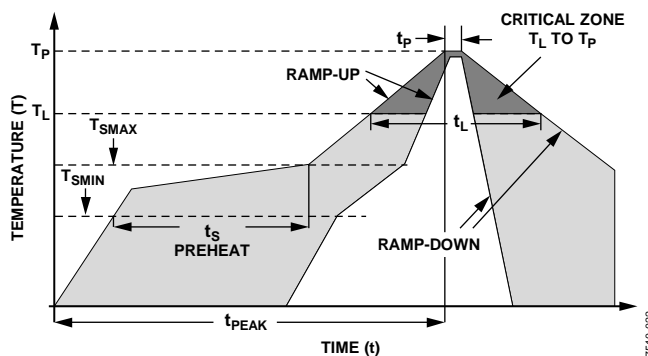

Figure 3. Soldering Profile Diagram

ABSOLUTE MAXIMUM RATINGS

Table 4.

Parameter	Rating
Acceleration (Any Axis, Unpowered and Powered)	4000 <i>g</i>
Supply Voltage, V_S	-0.3 V to +7.0 V
Output Short-Circuit Duration (V_{OUT} to GND)	Indefinite
Storage Temperature Range	-65°C to +150°C
Operating Temperature Range	-55°C to +125°C
Soldering Temperature (Soldering, 10 sec)	245°C

Stresses above those listed under Absolute Maximum Ratings may cause permanent damage to the device. This is a stress rating only; functional operation of the device at these or any other conditions above those indicated in the operational section of this specification is not implied. Exposure to absolute maximum rating conditions for extended periods may affect device reliability.

Drops onto hard surfaces can cause shocks of greater than 4000 *g* and can exceed the absolute maximum rating of the device. Exercise care during handling to avoid damage.

ESD CAUTION



ESD (electrostatic discharge) sensitive device. Charged devices and circuit boards can discharge without detection. Although this product features patented or proprietary protection circuitry, damage may occur on devices subjected to high energy ESD. Therefore, proper ESD precautions should be taken to avoid performance degradation or loss of functionality.

PIN CONFIGURATION AND FUNCTION DESCRIPTIONS

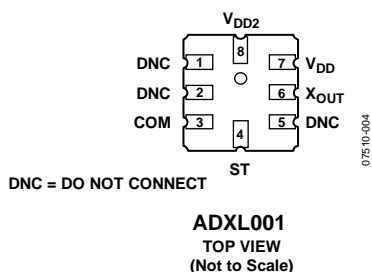

Figure 4. Pin Configuration

Table 5. Pin Function Descriptions

Pin No.	Mnemonic	Description
1, 2, 5	DNC	Do Not Connect.
3	COM	Common.
4	ST	Self-Test Control (Logic Input).
6	X _{OUT}	X-Axis Acceleration Output.
7	V _{DD}	3.135 V to 6 V. Connect to V _{DD2} .
8	V _{DD2}	3.135 V to 6 V. Connect to V _{DD} .

TYPICAL PERFORMANCE CHARACTERISTICS

$V_S = 3.3\text{ V}$, $T_A = 25^\circ\text{C}$, unless otherwise noted.

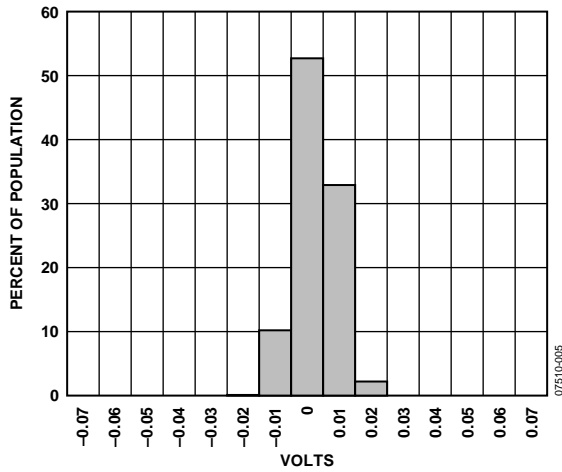

Figure 5. Zero-g Bias Deviation from Ideal

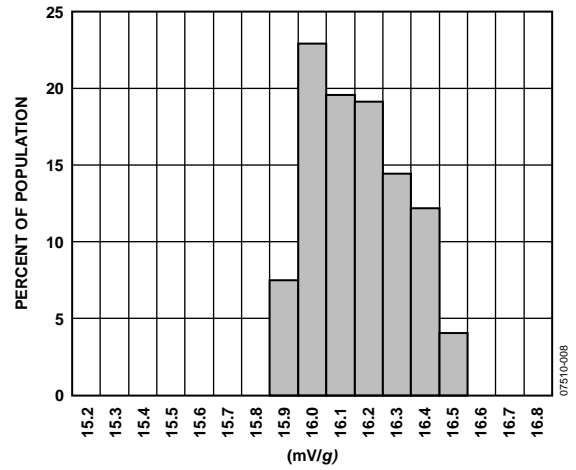

Figure 8. ADXL001-70, Sensitivity Distribution ($T_A = 125^\circ\text{C}$)

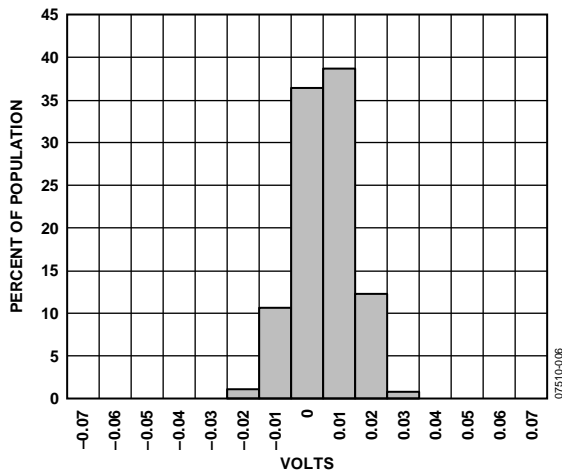

Figure 6. Zero-g Bias Deviation from Ideal ($T_A = 125^\circ\text{C}$)

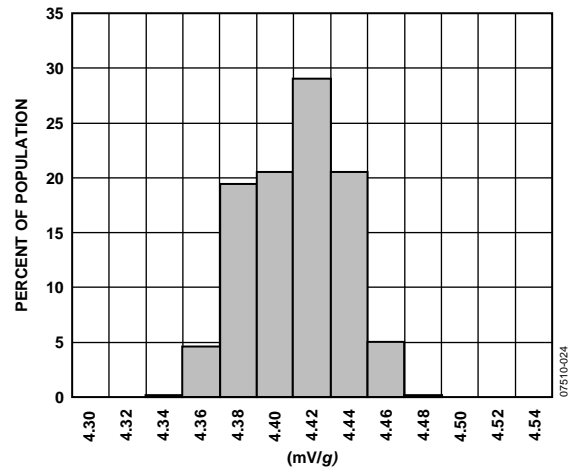

Figure 9. ADXL001-250, Sensitivity Distribution

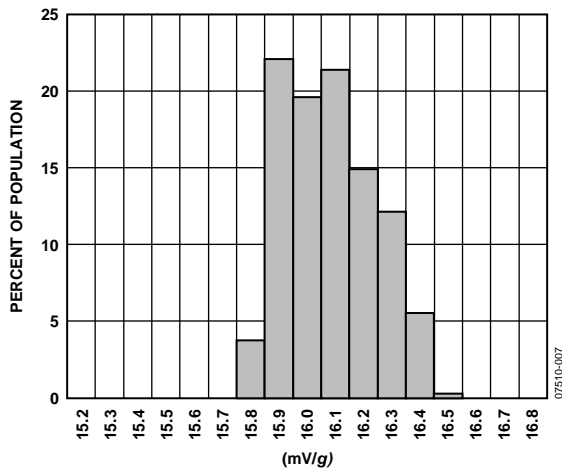

Figure 7. ADXL001-70, Sensitivity Distribution

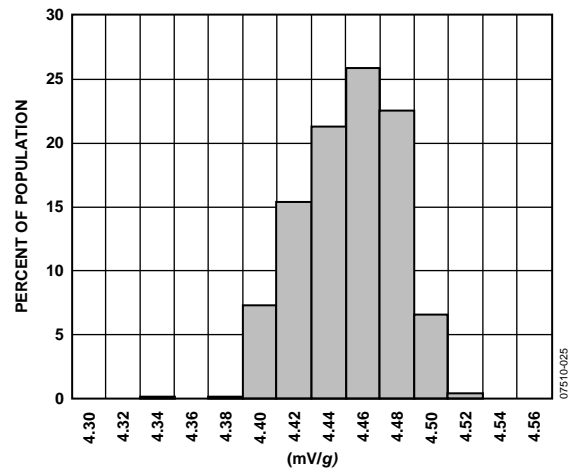

Figure 10. ADXL001-250, Sensitivity Distribution ($T_A = 125^\circ\text{C}$)

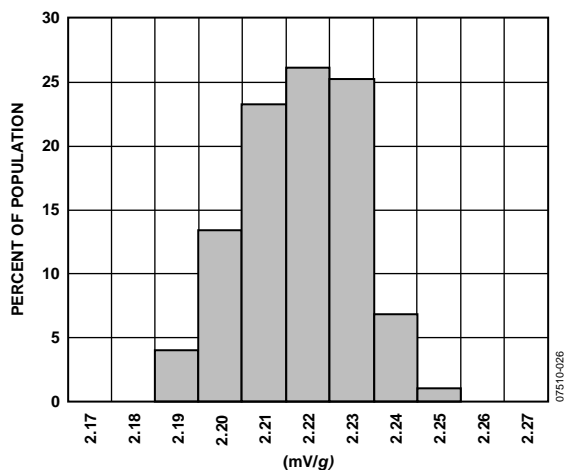

Figure 11. ADXL001-500, Sensitivity Distribution

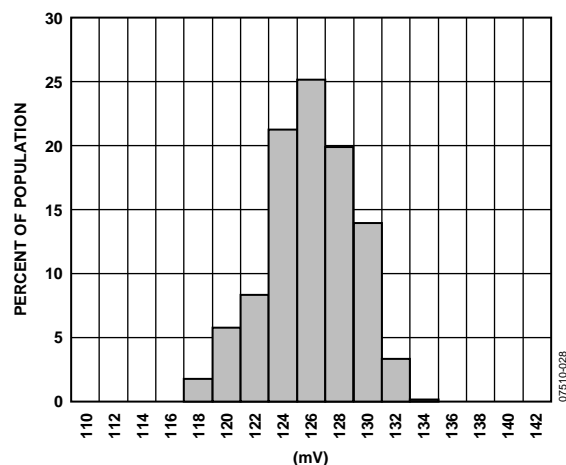

Figure 14. ADXL001-250, Self-Test Delta

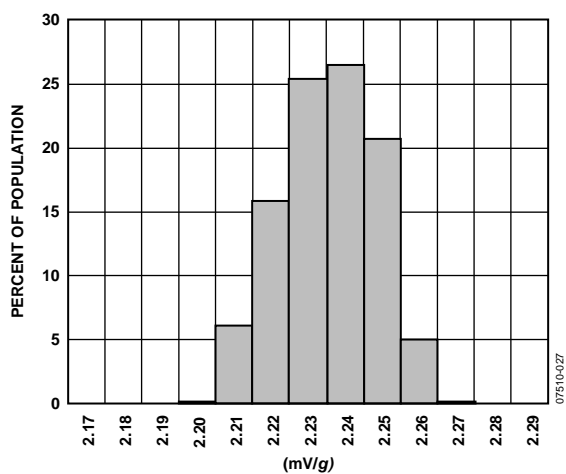

Figure 12. ADXL001-500, Sensitivity Distribution (TA = 125°C)

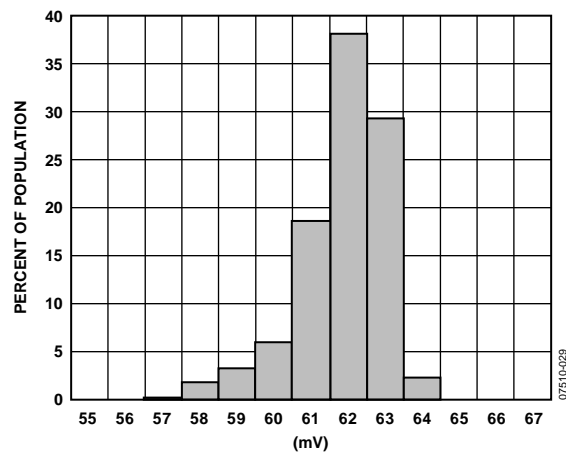

Figure 15. ADXL001-500, Self-Test Delta

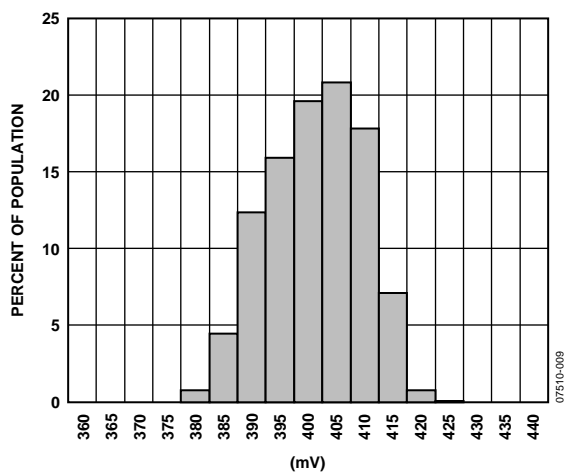

Figure 13. ADXL001-70, Self-Test Delta

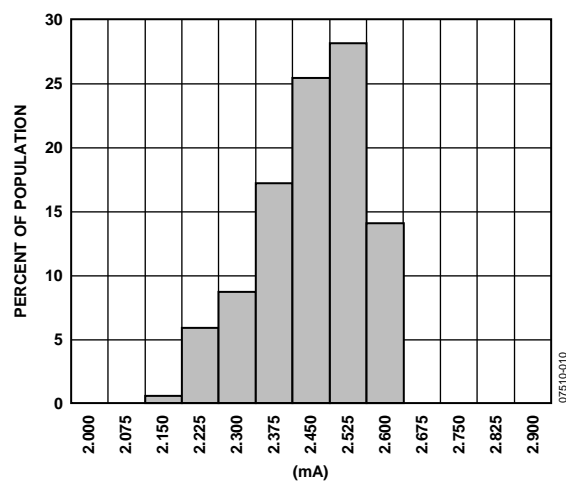

Figure 16. ISUPPLY Distribution

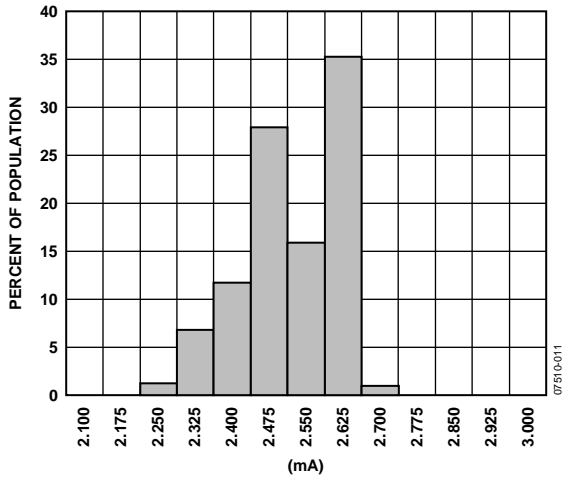

Figure 17. I_{SUPPLY} at 125°C

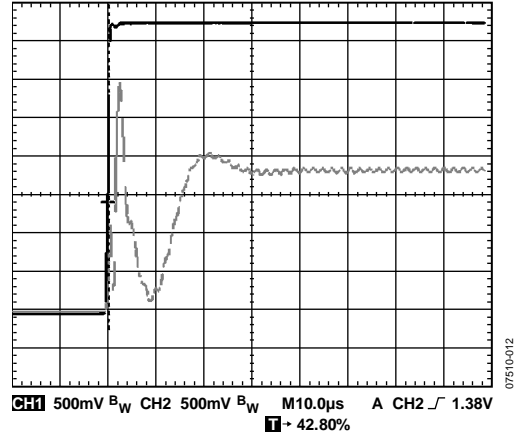

Figure 18. Turn-On Characteristic (10 μs per DIV)

THEORY OF OPERATION

DESIGN PRINCIPLES

The ADXL001 accelerometer provides a fully differential sensor structure and circuit path for excellent resistance to EMI/RFI interference.

This latest generation SOI MEMS device takes advantage of mechanically coupled but electrically isolated differential sensing cells. This improves sensor performance and size because a single proof mass generates the fully differential signal. The sensor signal conditioning also uses electrical feedback with zero-force feedback for improved accuracy and stability. This force feedback cancels out the electrostatic forces contributed by the sensor circuitry.

Figure 19 is a simplified view of one of the differential sensor cell blocks. Each sensor block includes several differential capacitor unit cells. Each cell is composed of fixed plates attached to the device layer and movable plates attached to the sensor frame. Displacement of the sensor frame changes the differential capacitance. On-chip circuitry measures the capacitive change.

MECHANICAL SENSOR

The ADXL001 is built using the Analog Devices SOI MEMS sensor process. The sensor device is micromachined in-plane in the SOI device layer. Trench isolation is used to electrically isolate, but mechanically couple, the differential sensing elements. Single-crystal silicon springs suspend the structure over the handle wafer and provide resistance against acceleration forces.

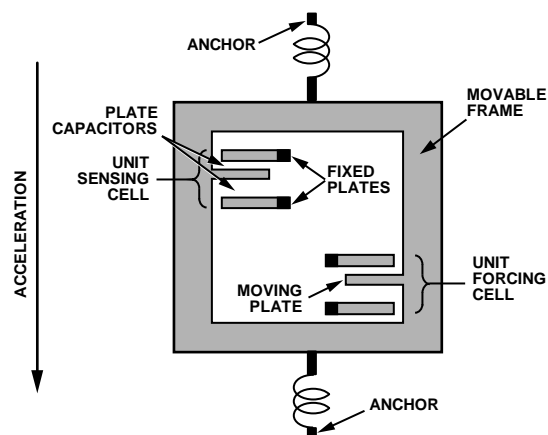

Figure 19. Simplified View of Sensor Under Acceleration

07510-019

APPLICATIONS INFORMATION

APPLICATION CIRCUIT

Figure 20 shows the standard application circuit for the ADXL001. Note that V_{DD} and V_{DD2} should always be connected together. The output is shown connected to a 1000 pF output capacitor for improved EMI performance and can be connected directly to an ADC input. Use standard best practices for interfacing with an ADC and do not omit an appropriate antialiasing filter.

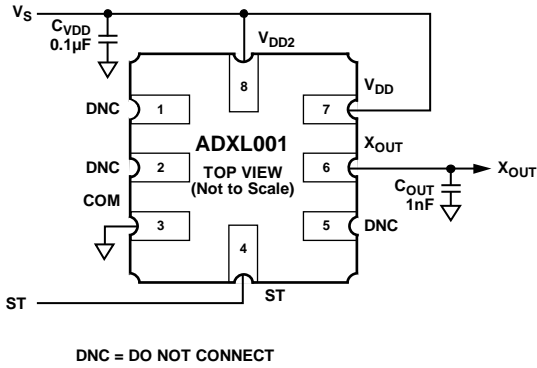

Figure 20. Application Circuit

SELF-TEST

The fixed fingers in the forcing cells are normally kept at the same potential as that of the movable frame. When the digital self-test input is activated, the ADXL001 changes the voltage on the fixed fingers in these forcing cells on one side of the moving plate. This potential creates an attractive electrostatic force, causing the sensor to move toward those fixed fingers. The entire signal channel is active; therefore, the sensor displacement causes a change in X_{OUT} . The ADXL001 self-test function verifies proper operation of the sensor, interface electronics, and accelerometer channel electronics.

Do not expose the ST pin to voltages greater than $V_S + 0.3$ V. If this cannot be guaranteed due to the system design (for instance, if there are multiple supply voltages), then a low V_F clamping diode between ST and V_S is recommended.

ACCELERATION SENSITIVE AXIS

The ADXL001 is an x-axis acceleration and vibration-sensing device. It produces a positive-going output voltage for vibration toward its Pin 8 marking.

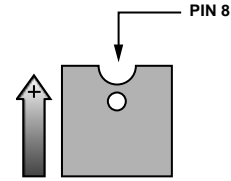

Figure 21. X_{OUT} Increases with Acceleration in the Positive X-Axis Direction

OPERATING VOLTAGES OTHER THAN 5 V

The ADXL001 is specified at $V_S = 3.3$ V and $V_S = 5$ V. Note that some performance parameters change as the voltage is varied.

In particular, the X_{OUT} output exhibits ratiometric offset and sensitivity with supply. The output sensitivity (or scale factor) scales proportionally to the supply voltage. At $V_S = 3.3$ V, the output sensitivity is typically 16 mV/g. At $V_S = 5$ V, the output sensitivity is nominally 24.2 mV/g. X_{OUT} zero-g bias is nominally equal to $V_S/2$ at all supply voltages.

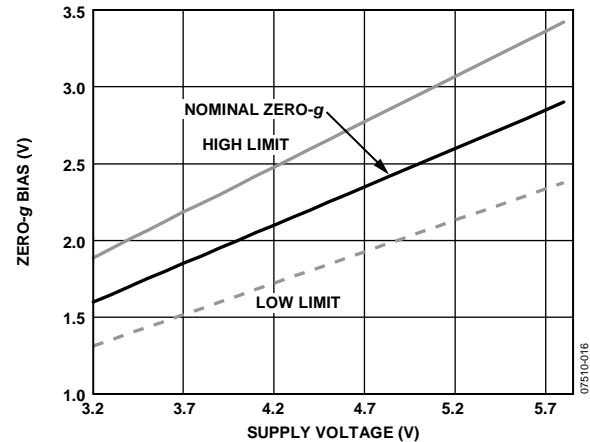

Figure 22. Typical Zero-g Bias Levels Across Varying Supply Voltages

Self-test response in gravity is roughly proportional to the cube of the supply voltage. For example, the self-test response for the ADXL001-70 at $V_S = 5$ V is approximately 1.4 V. At $V_S = 3.3$ V, the self-test response for the ADXL001-70 is approximately 400 mV. To calculate the self-test value at any operating voltage other than 3.3 V or 5 V, the following formula can be applied:

$$(ST\Delta @ V_x) = (ST\Delta @ V_S) \times (V_x/V_S)^3$$

where:

V_x is the desired supply voltage.

V_S is 3.3 V or 5 V.

LAYOUT, GROUNDING, AND BYPASSING CONSIDERATIONS

CLOCK FREQUENCY SUPPLY RESPONSE

In any clocked system, power supply noise near the clock frequency may have consequences at other frequencies. An internal clock typically controls the sensor excitation and the signal demodulator for micromachined accelerometers.

If the power supply contains high frequency spikes, they may be demodulated and interpreted as acceleration signals. A signal appears at the difference between the noise frequency and the demodulator frequency. If the power supply noise is 100 Hz away from the demodulator clock, there is an output term at 100 Hz. If the power supply clock is at exactly the same frequency as the accelerometer clock, the term appears as an offset. If the difference frequency is outside the signal bandwidth, the output filter attenuates it. However, both the power supply clock and the accelerometer clock may vary with time or temperature, which can cause the interference signal to appear in the output filter bandwidth.

The ADXL001 addresses this issue in two ways. First, the high clock frequency, 125 kHz for the output stage, eases the task of choosing a power supply clock frequency such that the difference between it and the accelerometer clock remains well outside the filter bandwidth. Second, the ADXL001 has a fully differential signal path, including a pair of electrically isolated, mechanically coupled sensors. The differential sensors eliminate most of the power supply noise before it reaches the demodulator. Good high frequency supply bypassing, such as a ceramic capacitor close to the supply pins, also minimizes the amount of interference.

The clock frequency supply response (CFSR) is the ratio of the response at the output to the noise on the power supply near the accelerometer clock frequency or its harmonics. A CFSR of 0.9 V/V means that the signal at the output is half the amplitude of the supply noise. This is analogous to the power supply rejection ratio (PSRR), except that the stimulus and the response are at different frequencies.

POWER SUPPLY DECOUPLING

For most applications, a single 0.1 μF capacitor, C_{DC} , adequately decouples the accelerometer from noise on the power supply. However, in some cases, particularly where noise is present at the 1 MHz internal clock frequency (or any harmonic thereof), noise on the supply can cause interference on the ADXL001 output. If additional decoupling is needed, a 50 Ω (or smaller) resistor or ferrite bead can be inserted in the supply line. Additionally, a larger bulk bypass capacitor (in the 1 μF to 4.7 μF range) can be added in parallel to C_{DC} .

ELECTROMAGNETIC INTERFERENCE

The ADXL001 can be used in areas and applications with high amounts of EMI or with components susceptible to EMI emissions. The fully differential circuitry of the ADXL001 is designed to be robust to such interference. For improved EMI performance, especially in automotive applications, a 1000 pF output capacitor is recommended on the X_{OUT} output.

OUTLINE DIMENSIONS

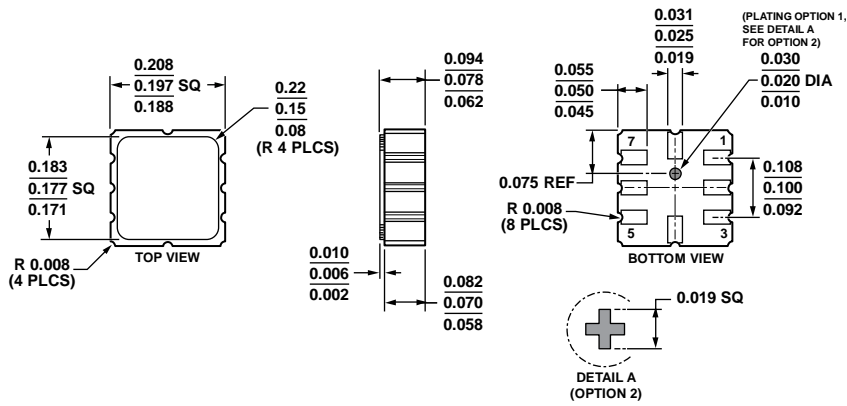

Figure 23. 8-Terminal Ceramic Leadless Chip Carrier [LCC]
(E-8-1)
Dimensions shown in inches

111808-C

ORDERING GUIDE

Model ¹	Temperature Range	g Range	Package Description	Package Option
ADXL001-70BEZ	-40°C to +125°C	±70 g	8-Terminal LCC	E-8-1
ADXL001-70BEZ-R7	-40°C to +125°C	±70 g	8-Terminal LCC	E-8-1
ADXL001-250BEZ	-40°C to +125°C	±250 g	8-Terminal LCC	E-8-1
ADXL001-250BEZ-R7	-40°C to +125°C	±250 g	8-Terminal LCC	E-8-1
ADXL001-500BEZ	-40°C to +125°C	±500 g	8-Terminal LCC	E-8-1
ADXL001-500BEZ-R7	-40°C to +125°C	±500 g	8-Terminal LCC	E-8-1
EVAL-ADXL001-250Z			Evaluation Board	
EVAL-ADXL001-500Z			Evaluation Board	
EVAL-ADXL001-70Z			Evaluation Board	

¹ Z = RoHS Compliant Part.

NOTES

ADXL001

NOTES